

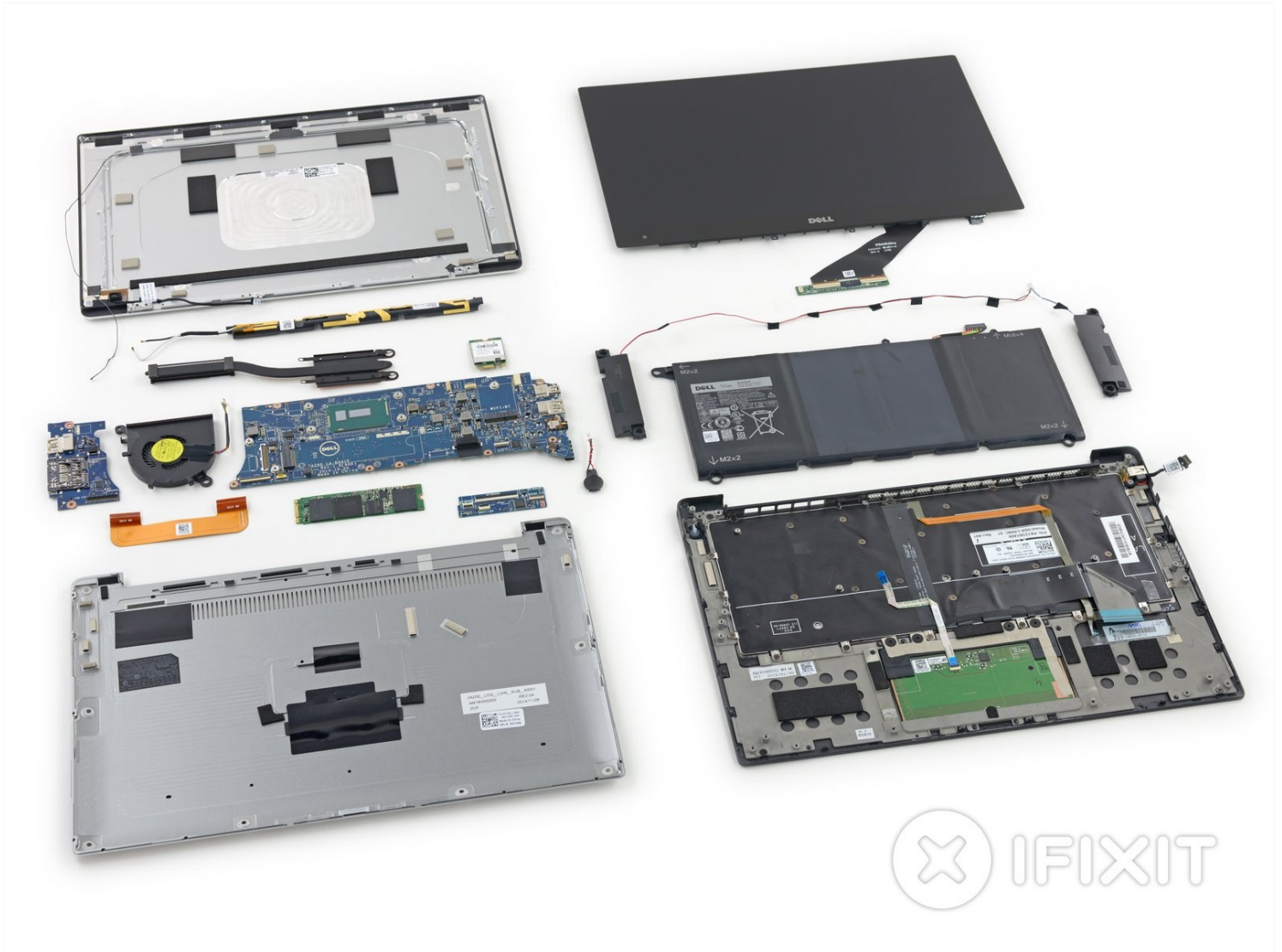

Dell XPS 13 Teardown

Dell says "no" to physics and threads a 13.3"...

Written By: Sam Goldheart



INTRODUCTION

Dell says "no" to physics and threads a 13.3" HD display into an impossibly small laptop. We're talking something an 11" display should call home. "How?" you may ask—well, we're out to get you an answer. The early 2015 Dell XPS 13 is our newest bit of teardown tech—time to tear it open!

Who's first to find out about the latest teardowns? You are—if you follow us on [Instagram](#), [Twitter](#), or [Facebook](#)!

TOOLS:

[Phillips #0 Screwdriver](#) (1)

[Phillips #1 Screwdriver](#) (1)

[T5 Torx Screwdriver](#) (1)

[iFixit Opening Picks \(Set of 6\)](#) (1)

[iFixit Opening Tool](#) (1)

[Spudger](#) (1)

[iOpener](#) (1)

[Tweezers](#) (1)

Step 1 — Dell XPS 13 Teardown



- Our specimen of Dell's compact XPS 13 features:
 - 13.3-inch "UltraSharp QHD+ infinity touch display" with 3200 x 1800 resolution
 - 8 GB Dual Channel DDR3L-RS 1600 MHz "onboard" RAM
 - 128 GB SSD
 - Plus, a little-mentioned webcam in the lower display bezel.
 - ⓘ This unusual placement probably allows for thinner top and side bezels. Unfortunately, this means getting an occasional keyboard in your selfie, not to mention [unflattering angles](#).

Step 2



- Dell folds space and time, packing 13.3 inches of laptop into an 11-inch form factor.
 - ① In reality, Dell gives up bezels and shaves the case width down to favor portability and highlight the "infinite" display and the full-size keyboard.
- While Apple uses its spare inches to make the MacBook Air look thinner and more streamlined, the XPS is clearly a compact competitor.
- ① In case you haven't guessed, we'll be making a few comparisons to the MacBook Air.
 - And because it's the *insides* that count, we're impatient to get to the guts.

Step 3



- The bottom of the laptop is surprisingly bare of any warnings or model numbers... but what's under door number XPS?
- A bizarrely magnetized, "spring-loaded" flap hides the FCC and Service Tag markings...
 - ① ...as well as a friendly labeled screw! While Dell freely shares the [entire service manual for the XPS 13](#), which is a huge point in their favor, road signs like which screw goes where are always welcome.
- Not ones to cheat on our homework, we'll see how easy it is to get into the laptop on our own two spudgers first...

Step 4



- Setting aside the driver that handy label called for, we whip out a T5 and dispatch the case screws.
- ① While requiring two different drivers just to get the thing open has us scratching our heads, at least we've got screws! That's better than the alternatives—gummy adhesive to cut or clips that may break.
- We spoke too soon—there are clips, too, and hefty ones at that. As we wrestle with the case, we're left wondering if Dell went for the trifecta: screws, clips, **and** glue?
- We finally remove the stubborn lower case, and it turns out that it was just some serious clippage fighting us. Definitely one of those "easier-when-you-know-how" opening procedures.

Step 5

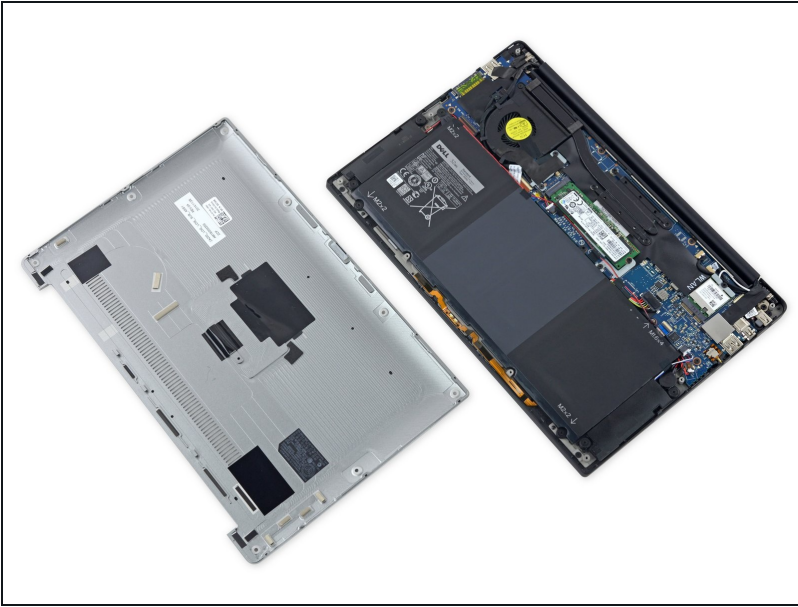

- A solid aluminum lower case? Flat, paneled battery? Upper logic *system* board with a single fan separating the main board from a smaller I/O board?
- [This looks familiar.](#)
- At first glance, this looks like a prototype MacBook Air—a bit less polished than the current gen, but strikingly similar.
- ① Similar *except* for the repair-friendly labels on every component and connector—that's something you don't see in an Apple product.

Step 6



- The battery connector is no easy pop-off top; it requires some precision spudgering to chase it out of its socket.
 - After that, it still isn't a perfectly clean getaway—the speaker wires are strategically taped to the battery in a half dozen spots, which we'll have to liberate to free the battery. (Admittedly, it [could have been a lot worse](#).)
 - These same wires are trapped under the battery screws—so speaker replacement means battery removal. It looks like the XPS has some [layering issues](#).
- ① At least the handy labels tell us which screws go where.

Step 7

3.

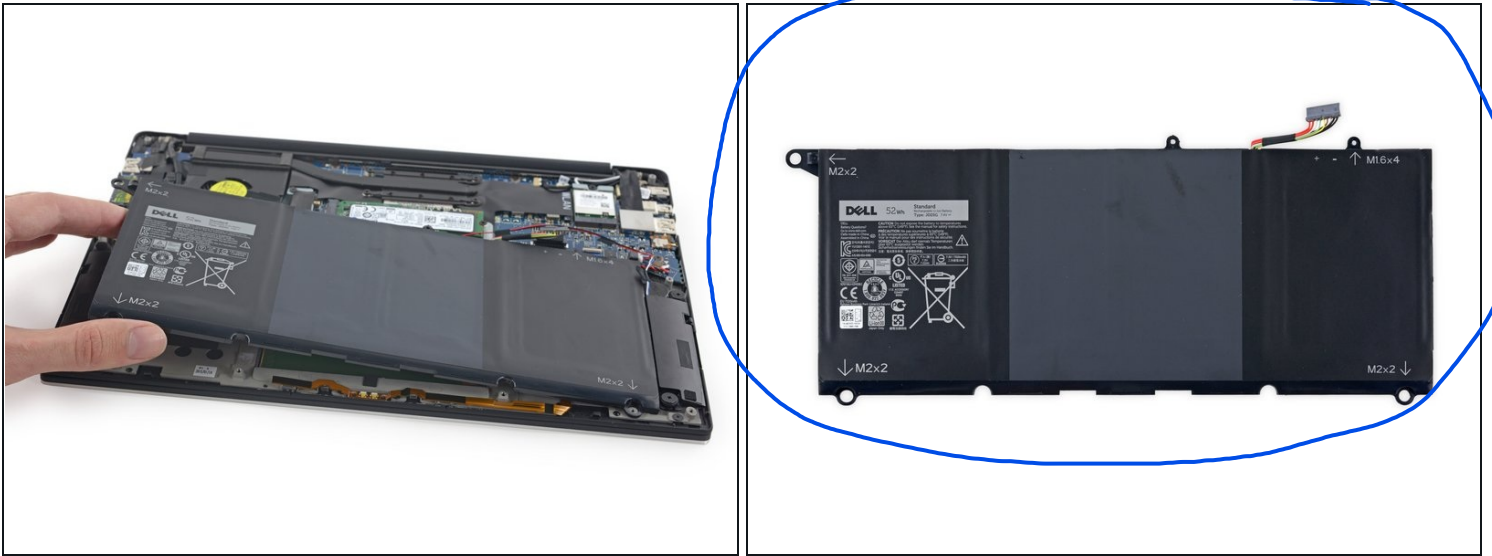

- The Dell XPS 13 features a four-cell, 7.4 V, 52 Wh battery with "up to 11 hours of run time."
 - ☑ That's 11 hours of web browsing, with "system brightness set to 150 nits (40%) and wireless on"—highly dependent on personal configuration and usage.
 - ⓘ Usage reports [vary](#) pretty [wildly](#) on the functional battery life.
- For comparison: Apple's Early 2014 MacBook Air claims 12 hours of web browsing or iTunes movie playback on its 54 Wh battery.

Step 8

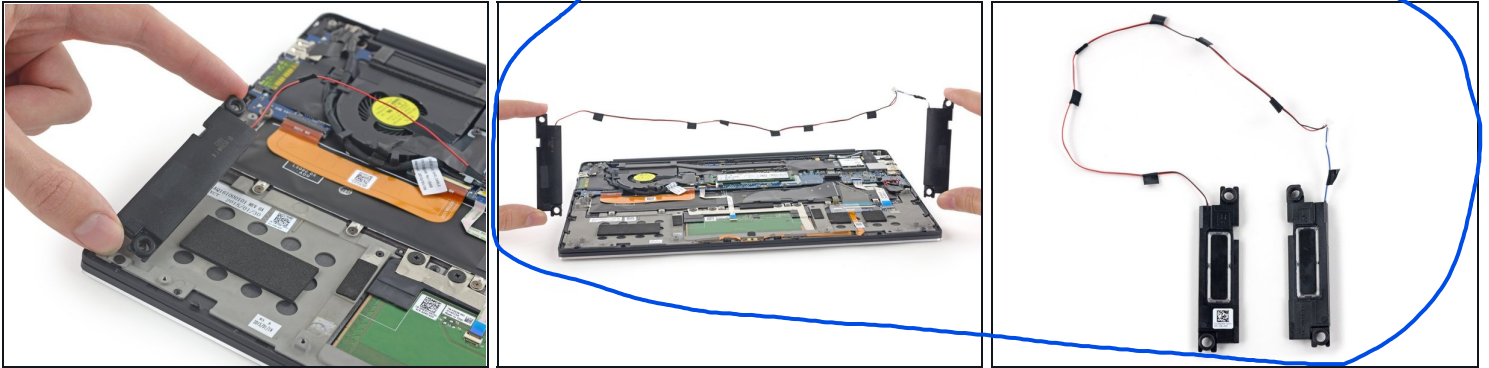

- With the battery out, the speakers are free to jump ship as well. 5
 - ⓘ The speakers rest on vibration dampening rubber grommets. Squishy.
- These speakers are really good friends. They go everywhere together. It's almost as if they're joined at the hip cable.
 - ⓘ Replacing a single speaker will require soldering to splice into the cable, or crimping wires into a new connector.
 - On the plus side, free nunchucks.

Step 9



- This particular XPS is packing a removable 128 GB [Samsung PM851](#) M.2 form factor SSD.
 - 2 x Samsung 431 K9CHGY8S5M-CCK0 64 GB TLC NAND flash
 - Samsung 428 [K4P2G324ED](#)-FGC2 512 MB LPDDR2 DRAM
 - Samsung [S4LN045X01-8030](#) MDX controller
- ① This is a well-established form factor for SATA 3 SSDs, so finding an upgrade or replacement will be as easy as [something that's really easy](#).
- But wait, there's more! This SSD comes complete with an [unremarkable underside](#).

Step 10



- With [tweezers](#) in hand, we easily dispatch the wireless card grounding bracket. 1.
- Underneath, we find a Broadcom DW1560 Wi-Fi/Bluetooth 4.0 LE card, featuring:
 - Broadcom [BCM4352KML](#) 5G WiFi 2-stream 802.11ac transceiver
 - Broadcom [BCM20702](#) single-chip Bluetooth 4.0 solution with BLE support
 - Skyworks [SE5516](#) dual-band 802.11a/b/g/n/ac WLAN front-end module

Step 11

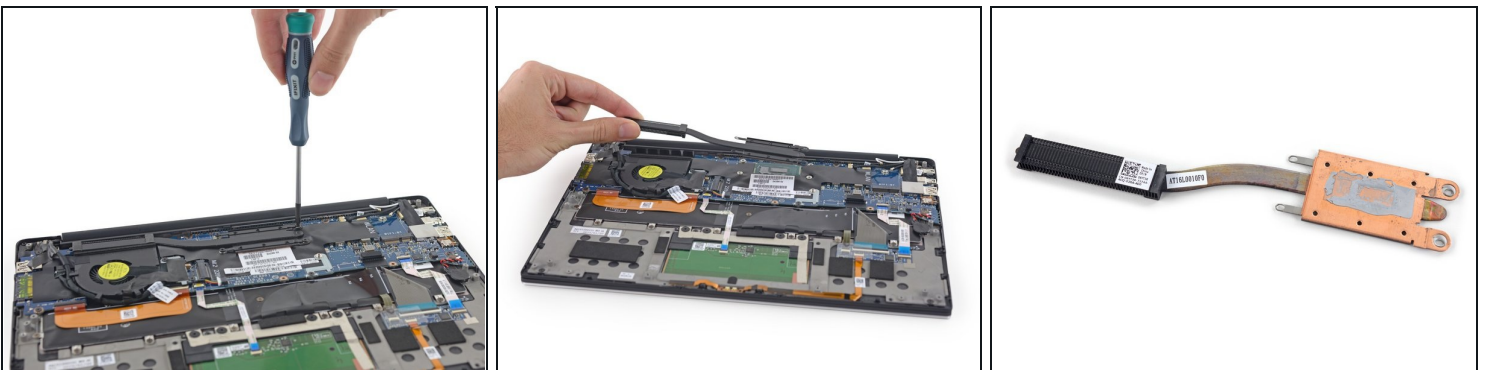

- Time to get into some more exciting bits: eyes on the heat sink. Said sink looks [awfully similar](#) to that of the Early 2014 MacBook Air.
- It comes complete with some crusty thermal paste. Yum.
- ① Lately, we've seen a trend toward smaller heat sinks as Intel improves its processors' thermal efficiency. The Core i5-5200U loaded in the XPS 13 rates 15 watts of thermal design power.

Step 12



- Tape, cables, and labeled connectors have been the defining characteristics of the XPS 13's guts. There are a lot of components, with a lot of connecting cables, and a lot of tape holding everything down.
 - ⓘ At least it's tough, re-stickable fabric tape.
- There's a small (labeled!) coin cell battery to keep the real-time clock running. We're expecting [this sort of reaction](#) when we reassemble the computer and power it back on.
- To get anywhere, we're going to have to disconnect the XPS's odd display cable.
 - Not only is it wrapped snugly around the fan, but, for some reason, it includes a branch to power the SD card reader on the I/O board.

Step 13

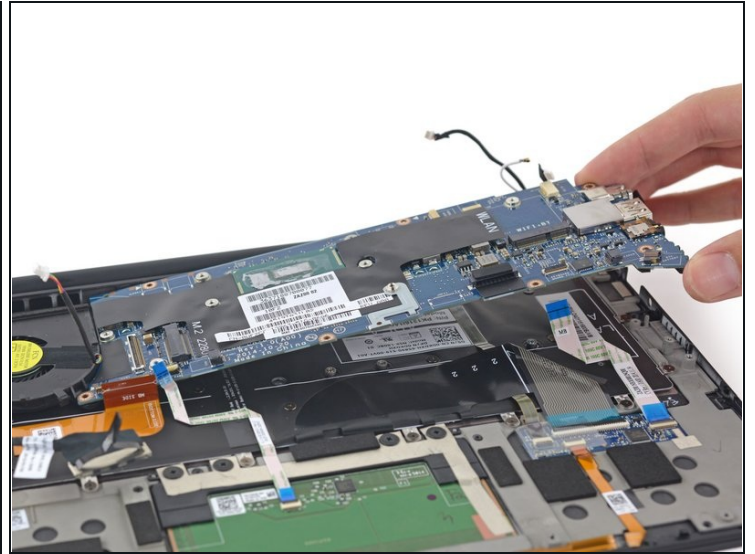

- Full disclosure: Once we got inside the XPS, we sort of started cheating on our homework—by following Dell's [service manual](#) as a disassembly guide. What can we say, we love repair documentation.
 - So when we got to the bit instructing us to remove the system board to take out the fan, we were a bit confused, amused, and eventually miffed.
- ① It looks to us like with some more detailed instructions, it would be pretty easy to skip removing the entire board and just pop up a corner. [If only there were some sort of freely available repair documentation platform available on the internet.](#)

Step 14

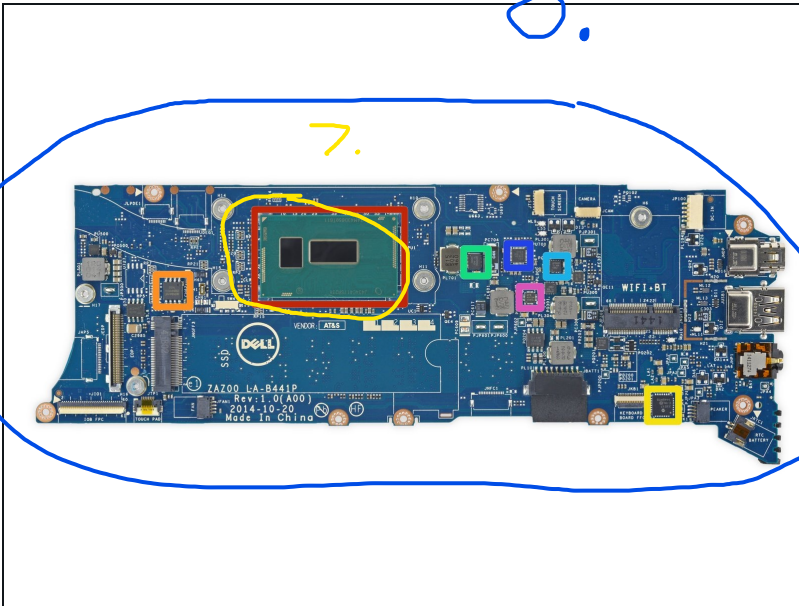

- With the motherboard removed, let's take a look at what this XPS is packing:
- 5th Generation Intel [Core i5-5200U](#) processor (up to 2.70 GHz) with Intel HD Graphics 5500
- Winbond [25Q64FVS10](#) 64 M-bit serial flash memory
- Microchip Technologies [MCP23017](#) 16-bit input/output port expander with interrupt output
- Texas Instruments [CSD97374Q4M](#) high frequency synchronous buck NexFET power stage
- Texas Instruments [CSD87330Q3D](#) synchronous buck NexFET power block
- Texas Instruments [TPS51624](#) 4.5 V to 28 V, 1/2-phase step-down driverless controller
- ANPEC [APW8813/A](#) DDR2 and DDR3 power solution synchronous buck controller with 1.5 A LDO

Step 15

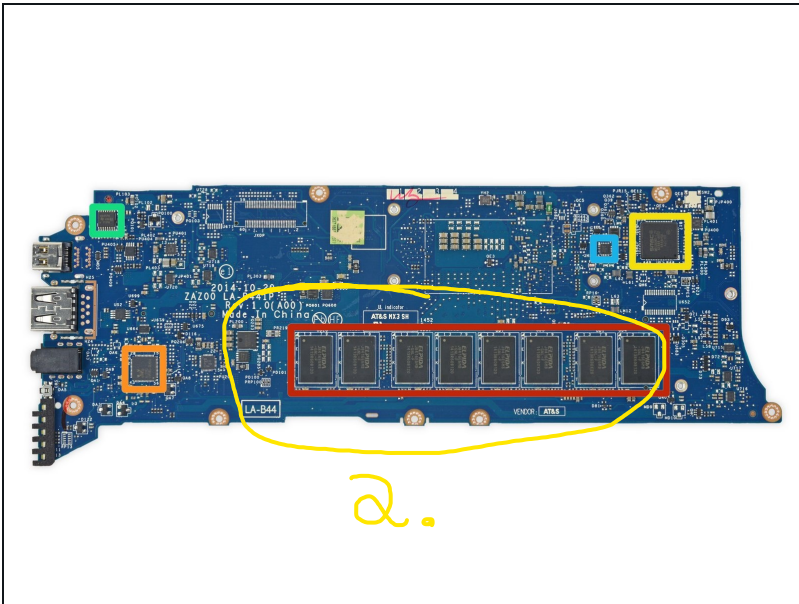

- Mas chips, por favor!
 - Elpida/Micron J8416E6MB-GNL-F 8 GB (8 x 1 GB) DDR3L-RS 1600 MHz dual-channel RAM
 - ⚠ Buyer beware: Just like in the MacBooks Air and Retina, the RAM in the XPS 13 is soldered to the motherboard, and cannot be replaced. When you're picking out your new laptop, configure what you think it'll need...*forever*.
 - Realtek ALC3263 audio codec
 - SMSC MEC5085 low power embedded flash
 - Texas Instruments [SN74CBT3257C](#) 4-bit 1-of-2 FET multiplexer/demultiplexer, 5 V bus switch
 - ON Semiconductor [NCP4545](#) controlled load switch

Step 16



- The XPS 13's biggest only fan.
- What can we say, it's a fan. It runs at 5 volts and 0.5 amps, for a whopping 2.5 watts of super-exciting centrifugal cooling power.
- ① We're a little miffed that we had to come this far to get the fan out, and that it doesn't share the same vibration-dampening considerations as its speaker brethren.
 - Without rubber mounting grommets, it may well develop a noise issue in the future. Needless to say, we don't want any of that jibber jabber.

Step 17

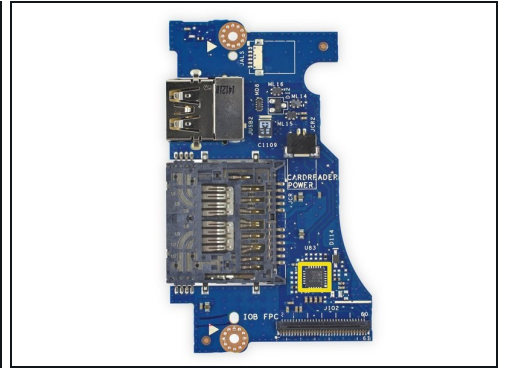
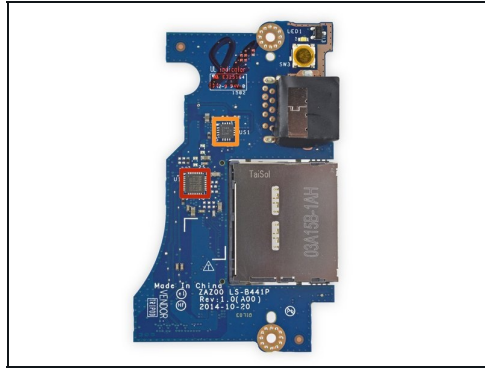

- Alright, that's enough. This construction is more than a little ridiculous. Waiter! There's a screw in my tape!
- After some screwy disassembly, we free the I/O board and find:
 - Realtek RTS5249 card reader controller
 - Texas Instruments [TPS2544](#) USB charging port controller and power switch
 - Parade [PS8713B](#) single port USB 3.0 repeater/redriver

Step 18



- We scoop out the last* of the exciting** bits: an LED indicator cable, and this weird interconnect board!
- * Technically we still have the trackpad, keyboard, and DC-in port.
- ** Author's discretion
- Living on the interconnect board and managing the keyboard, keyboard backlight, front LEDs, and dual mics:
 - SMSC (Microchip) [ECE1117](#) multi-function BC-Link/SMBus companion device

Step 19

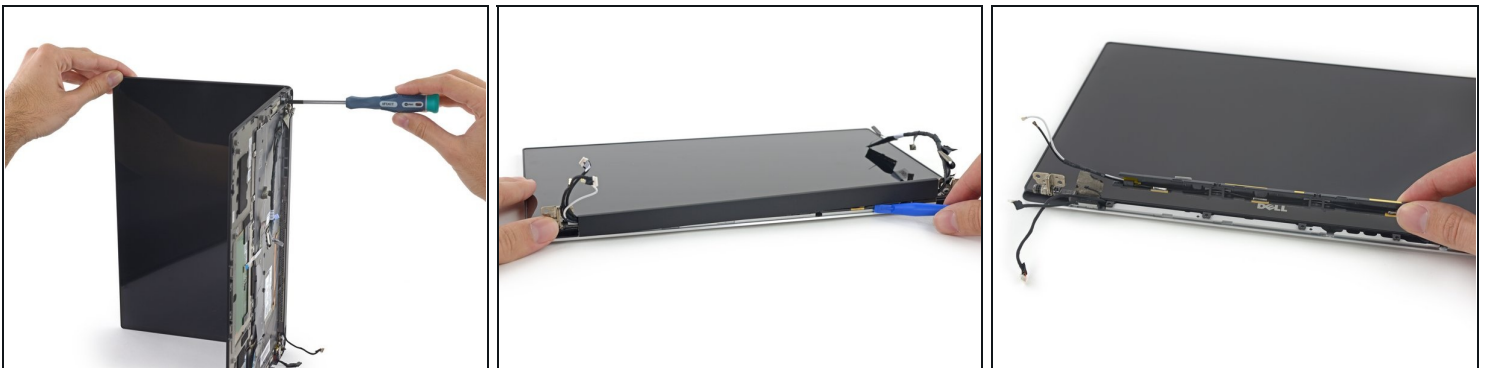

- Enough dilly-dallying, let's get to the fun part. The new exciting feature that Dell is really trying to sell here: The ultra high def, infinity-edged touch screen display.
- Wait did we accidentally get a MacBook display somehow? [Déjà vu...](#)
- The clutch cover comes off in much the same way as on a MacBook Pro, revealing a [plastic frame of antennas](#).

Step 20



- We're getting [pretty good](#) at [prying up glass](#), so we've got some idea of where to start.
 - Step 1: Load up on heat. Use plenty of [iOpeners](#). (Or one iOpener plenty of times).
 - Step 2: Pry gently in many places. [Opening Picks](#) are the ideal tool.
 - Step 3: ???
 - Step 4: The edges you just heated are nowhere near the adhesive you wanted to loosen. The adhesive is entirely under the LCD panel.
 - Step 4b: [Apply plenty of heat to the back](#) and pry slowly.
- ① An [infinity pool](#) has no visible edge, making the water appear infinite. Using the transitive property, we deduce that an infinity display has... infinite glue?

Step 21

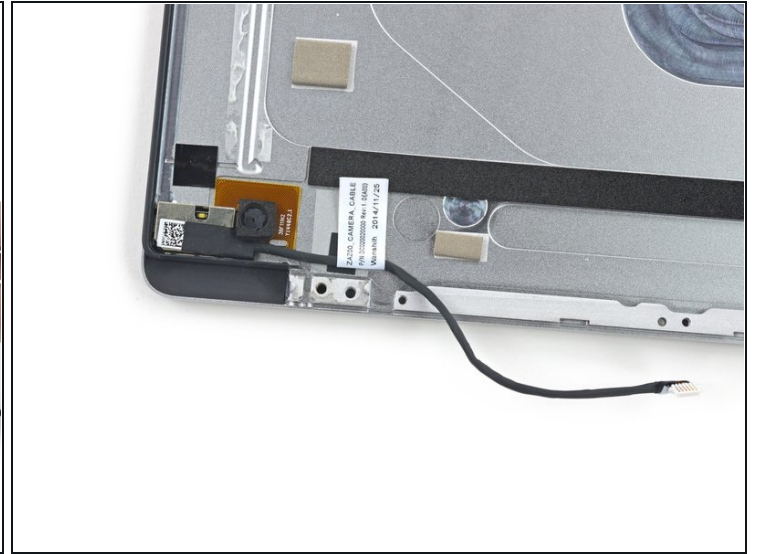

- Whew! Okay, not heck-tons of adhesive, but it packs a punch. You'd better peel slowly and use plenty of heat. That's some thin glass.
- With the display fully out of the top case, we get a peek at the peeper of a selfie-cam.

Step 22

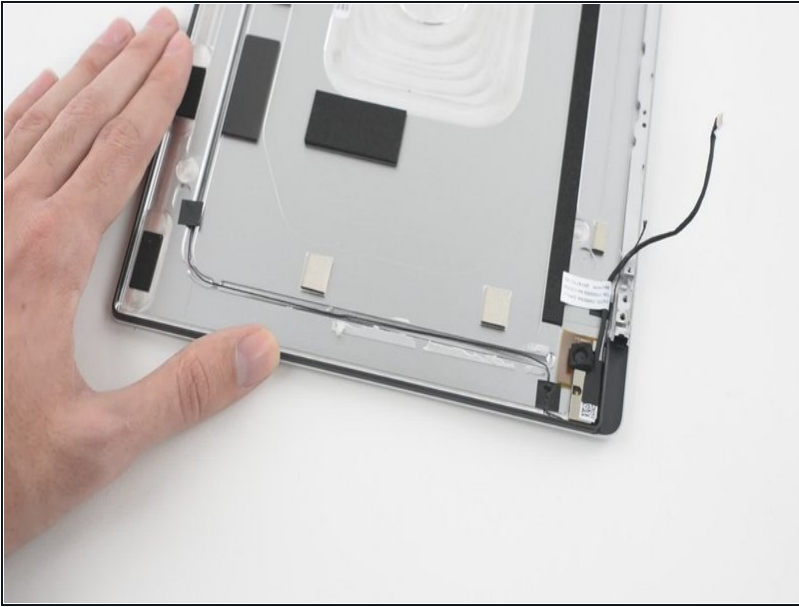

- After painstakingly cracking the clam, we find a mysterious black thread running along the inside of the top case.
- There's no mention in the service manual, but we're betting we just stumbled onto the easy way to get the LCD out—without the pain or the staking.
- The thread is routed in a channel beneath the display adhesive—pulling along the side ought to slice right through and free the panel, like [cutting clay off a block](#).
- We can't say for sure if this works without taking apart *another* XPS 13, but signs point to an awesome repair Easter egg.

Step 23

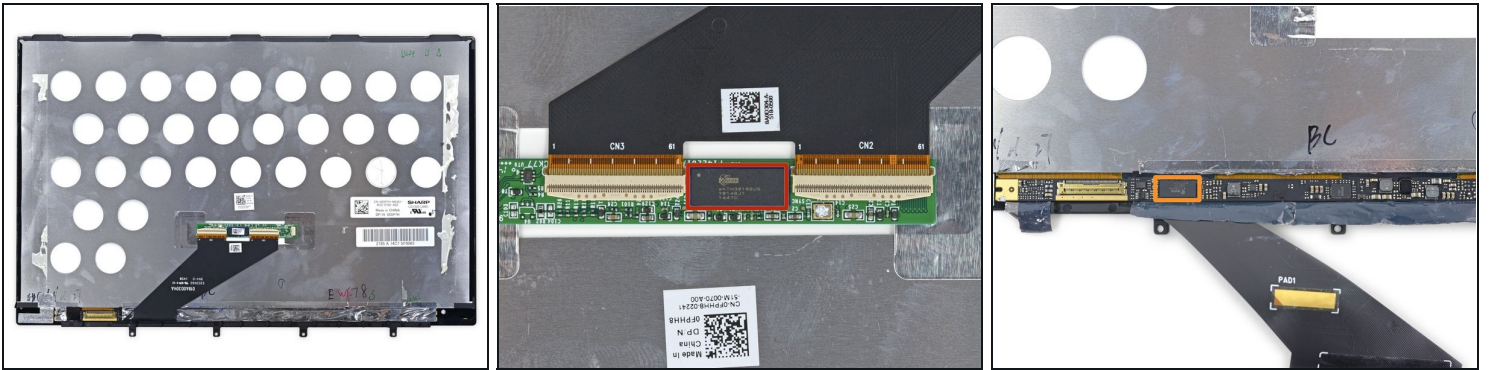

- That's quite a *Sharp* display assembly!
- Since we splurged for the touchscreen model, we had to find the digitizer control. Here it is, an Elan Microelectronics eKTH3915SUS.
- The display driver board lives under some foil tape at the bottom of the panel.
 - Novatek [NT71394MB8](#) display driver IC

Step 24

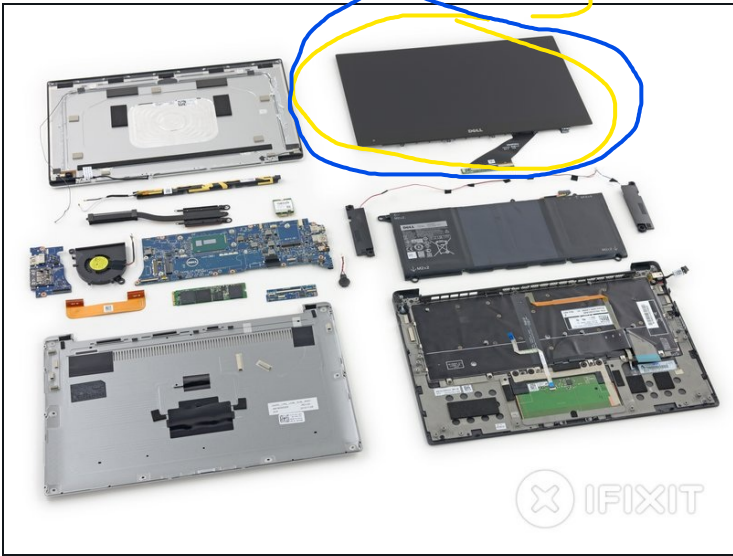

REPAIRABILITY SCORE:



- Dell XPS 13 Repairability Score: **7 out of 10** (10 is easiest to repair).
 - Service manuals are available online, for free. Thanks, Dell!
 - Once you manage to take off the bottom cover, all the parts are pretty easily replaceable.
 - Screws and connectors are labeled, aiding reassembly.
 - Moderate adhesive—except for the display assembly, no heat is required to disassemble.
 - The layering could be improved to make certain components easier to remove, but overall the modular design makes repairs cheaper.
 - Soldered RAM means you'll never be able to upgrade when things get slow.

To reassemble your device, follow these instructions in reverse order.